

# LED Lighting



# LED Lighting



Superslim 28

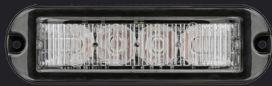

Maxiview 30



Slimline 32



LED Warning Bar 34



Covert Series 36



LED Hide-A-Way 37



Bus Warning Light Kits 38

# LED Lighting

Superslim

OS-KLSLED33B-BB



OS-KLSLED04B-RR



- Ultra-bright 3W LEDs.
- Superslim design – 11mm.
- Combination optics ensure 150° ultra-wide light dispersion.
- 22 flash patterns.
- Dimming function.
- Can be synchronised.
- Covert applications – install without rubber gasket.
- Low current draw.
- Multi-voltage.
- Environmentally sealed – IP67.
- 5-year warranty.

Voltage :	12–24V
Lens :	Polycarbonate
Flash Patterns :	22
Cable Length :	180mm
Approvals :	ECE R10
Light Source :	3W LEDs
Ingress Protection :	IP67



Covert applications – install without rubber gasket

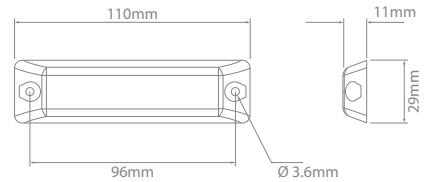

## Superslim – 4 LED (1x4)

- Amber      Blue      Green      Red      White      Red/Blue
- OS-KLSLED04B-AA   OS-KLSLED04B-BB   OS-KLSLED04B-GG   OS-KLSLED04B-RR   OS-KLSLED04B-WW   OS-KLSLED04B-RB

1.0A @ 12V



NEW

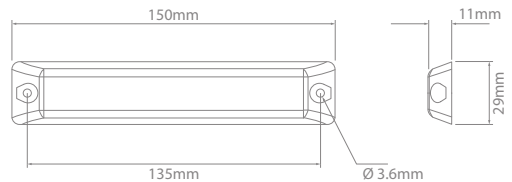

## Superslim – 6 LED (1x6) NEW

- Amber      Blue      Green      Red      White      Red/Blue
- OS-KLSLED06B-AA   OS-KLSLED06B-BB   OS-KLSLED06B-GG   OS-KLSLED06B-RR   OS-KLSLED06B-WW   OS-KLSLED06B-RB

1.3A @ 12V

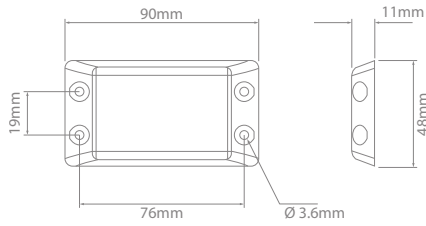

## Superslim – 6 LED (2x3)

Amber    Blue    Green    Red    White    Red/Blue  
**OS-KLSLED23B-AA**   **OS-KLSLED23B-BB**   **OS-KLSLED23B-GG**   **OS-KLSLED23B-RR**   **OS-KLSLED23B-WW**   **OS-KLSLED23B-RB**

1.3A @ 12V

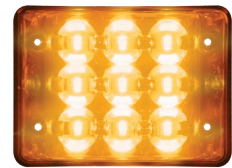
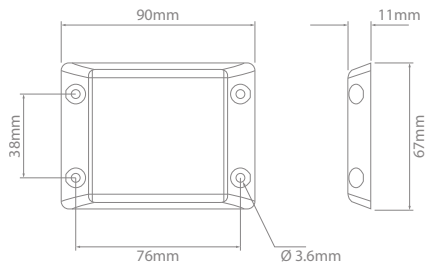

## Superslim – 9 LED (3x3)

Amber    Blue    Green    Red    White    Red/Blue  
**OS-KLSLED33B-AA**   **OS-KLSLED33B-BB**   **OS-KLSLED33B-GG**   **OS-KLSLED33B-RR**   **OS-KLSLED33B-WW**   **OS-KLSLED33B-RB**

1.5A @ 12V



OS-KLSLED04B-BKT



OS-KLSLED23B-BKT



OS-KLSLED33B-BKT

## Superslim – Mounting Brackets

4 LED (1x4)    6 LED (2x3)    9 LED (3x3)  
**OS-KLSLED04B-BKT**   **OS-KLSLED23B-BKT**   **OS-KLSLED33B-BKT**



# LED Lighting

Maxiview



OS-KRLED03B-M

- Ultra-bright 3W LEDs.
- Optic design provides ultra-wide 180° light dispersion.
- Up to 25 flash patterns.
- Dimming function.
- Low current draw.
- Epoxy-encapsulated electronics for environmental & vibration protection.
- LEDs rated to 100,000 hours of operation.
- Can be synchronised.
- Multi-voltage.
- Environmentally sealed – IP67.
- 5-year warranty.



Voltage :	12–24V
Lens :	Polycarbonate
Cable Length :	180mm
Approvals :	ECE R10, SAE Class 1
Light Source :	3W LEDs
Ingress Protection :	IP67

## 180° Light Dispersion

The Maxiview Series LEDs utilise an innovative lens design delivering 180° light dispersion.

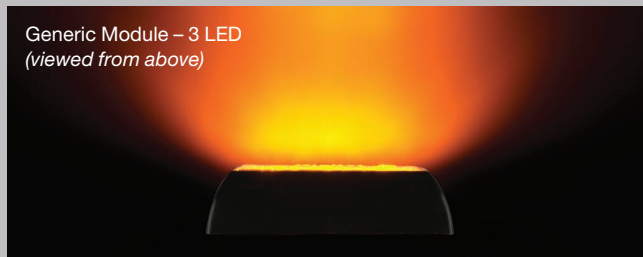
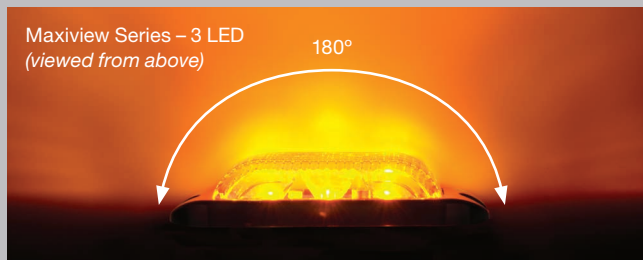
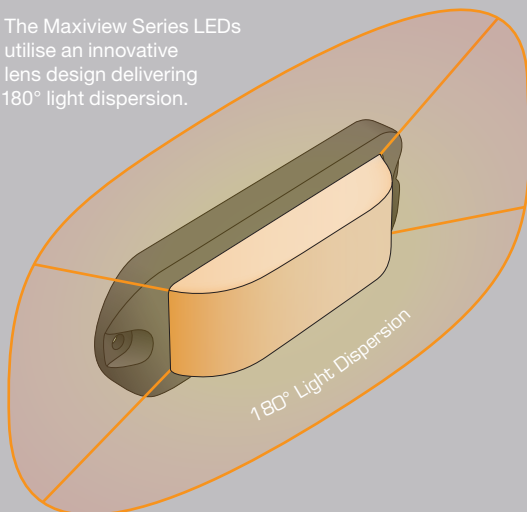

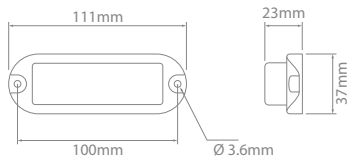

## Maxiview – 3 LED

- Amber  
**OS-KRLED03B-A**
- Blue  
**OS-KRLED03B-B**
- Green  
**OS-KRLED03B-G**
- Magenta  
**OS-KRLED03B-M**
- Red  
**OS-KRLED03B-R**
- White  
**OS-KRLED03B-W**

0.5A @ 12V.  
12 Flash Patterns.

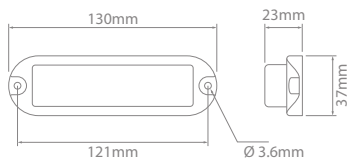

## Maxiview – 4 LED

- Amber  
**OS-KRLED04B-AA**
- Blue  
**OS-KRLED04B-BB**
- Green  
**OS-KRLED04B-GG**
- Magenta  
**OS-KRLED04B-MM**
- Red  
**OS-KRLED04B-RR**
- White  
**OS-KRLED04B-WW**
- Red/Blue  
**OS-KRLED04B-RB**

1.0A @ 12V.  
25 Flash Patterns.



## Maxiview – Mounting Brackets

- 3 LED  
**OS-KRLED03B-BKT**
- 4 LED  
**OS-KRLED04B-BKT**



# LED Lighting

Slimline



OS-KSLED06B-WW



OS-KSLED24B-AA



- Ultra-bright 3W LEDs.
- 25 flash patterns.
- Dimming function.
- Low current draw.
- Epoxy-encapsulated electronics for environmental & vibration protection.
- LEDs rated to 100,000 hours of operation.
- Can be synchronised.
- Multi-voltage.
- Environmentally sealed – IP67.
- 5-year warranty.

Voltage :	12–24V
Lens :	Polycarbonate
Flash Patterns :	25
Cable Length :	180mm
Approvals :	ECE R10, SAE Class 1
Light Source :	3W LEDs
Ingress Protection :	IP67

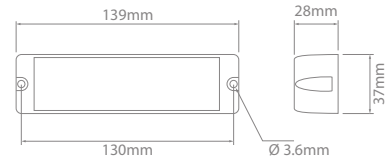

## Slimline – 4 LED (1x4)

- |                       |                       |                       |                       |                       |
|-----------------------|-----------------------|-----------------------|-----------------------|-----------------------|
| Amber                 | Blue                  | Red                   | White                 | Red/Blue              |
| <b>OS-KSLED04B-AA</b> | <b>OS-KSLED04B-BB</b> | <b>OS-KSLED04B-RR</b> | <b>OS-KSLED04B-WW</b> | <b>OS-KSLED04B-RB</b> |

1.0A @ 12V.

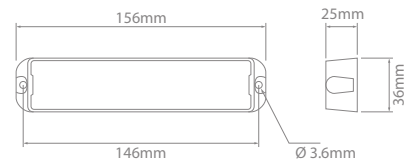

## Slimline – 6 LED (1x6)

- |                       |                       |                       |                       |                       |
|-----------------------|-----------------------|-----------------------|-----------------------|-----------------------|
| Amber                 | Blue                  | Red                   | White                 | Red/Blue              |
| <b>OS-KSLED06B-AA</b> | <b>OS-KSLED06B-BB</b> | <b>OS-KSLED06B-RR</b> | <b>OS-KSLED06B-WW</b> | <b>OS-KSLED06B-RB</b> |

1.0A @ 12V.

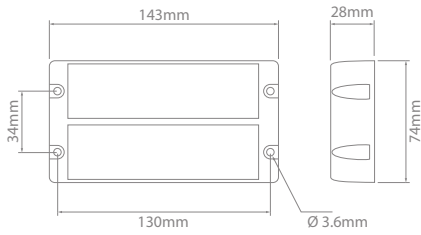

## Slimline – 8 LED (2x4)

- Amber  
**OS-KSLED24B-AA**
- Blue  
**OS-KSLED24B-BB**
- Red  
**OS-KSLED24B-RR**
- White  
**OS-KSLED24B-WW**
- Amber/White  
**OS-KSLED24B-WA**
- Red/Blue  
**OS-KSLED24B-RB**

Other colour combinations available upon request.  
2.0A @ 12V.

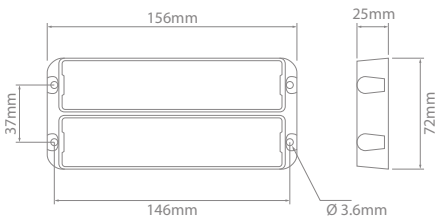

## Slimline – 12 LED (2x6)

- Amber  
**OS-KSLED26B-AA**
- Red  
**OS-KSLED26B-RR**
- White  
**OS-KSLED26B-WW**
- Red/Blue  
**OS-KSLED26B-RB**

Other colour combinations available upon request.  
2.0A @ 12V.



OS-KSLED04B-BKT



OS-KSLED06B-BKT

## Slimline – Mounting Brackets

- 4 LED (1x4)  
**OS-KSLED04B-BKT**
- 6 LED (1x6)  
**OS-KSLED06B-BKT**





# LED Lighting

## LED Warning Bar



12V  
24V

5Yrs

- High output, wide viewing angle.
- Up to 26 flash patterns.
- Dimming function.
- Multiple mounting options.
- Low current draw.
- Can be synchronised.
- Virtually unlimited colour combinations available (upon request).
- Epoxy-encapsulated electronics for environmental & vibration protection.
- LEDs rated to 100,000 hours of operation.
- Multi-voltage.
- 5-year warranty.

Voltage :	12-24V
Lens :	Polycarbonate
Body :	Aluminium
Approvals:	SAE-W-07
Light Source :	1W LEDs
Cable Length :	1m
Ingress Protection :	LED Module IP67



Channel on rear of the bar can be used with bolts for mounting (bolts not supplied)



Supplied brackets allow for mounting on angled surfaces



### Versatility

The robust aluminium housing and multiple mounting options allow the IONNIC LED Warning Bar to be used in many applications, inside or outside.



# LED Lighting

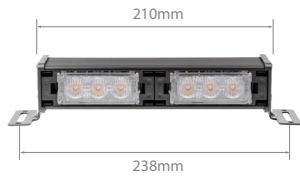

2 LED Modules



4 LED Modules

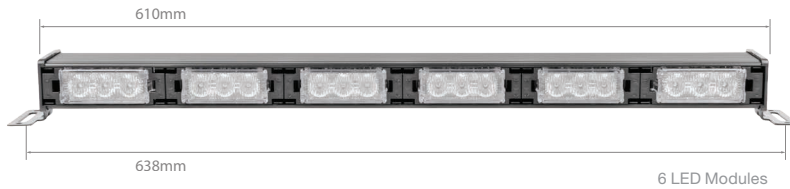

6 LED Modules

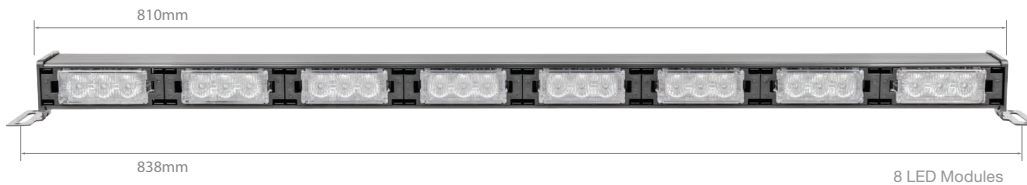

8 LED Modules



10 LED Modules

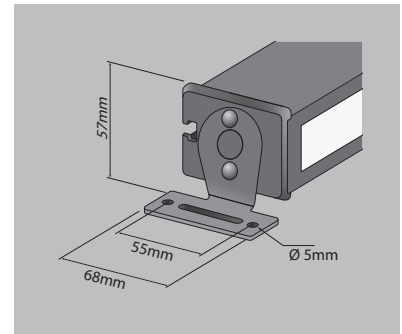

## LED Warning Bars – Single Colour

LED Modules	Current Draw @ 12V (A)	Flash Patterns	Amber	Blue	Green	Red	Magenta <span style="color:red">NEW</span>	White
2	0.7	17	<b>LSWLS-32A</b>	<b>LSWLS-32B</b>	<b>LSWLS-32G</b>	<b>LSWLS-32R</b>	<b>LSWLS-32M</b>	<b>LSWLS-32W</b>
4	1.4	26	<b>LSWLS-34A</b>	<b>LSWLS-34B</b>	<b>LSWLS-34G</b>	<b>LSWLS-34R</b>	—	<b>LSWLS-34W</b>
6	2.1	26	<b>LSWLS-36A</b>	<b>LSWLS-36B</b>	<b>LSWLS-36G</b>	<b>LSWLS-36R</b>	—	<b>LSWLS-36W</b>
8	2.8	26	<b>LSWLS-38A</b>	<b>LSWLS-38B</b>	<b>LSWLS-38G</b>	<b>LSWLS-38R</b>	<b>LSWLS-38M</b>	<b>LSWLS-38W</b>
10	3.5	26	<b>LSWLS-310A</b>	<b>LSWLS-310B</b>	<b>LSWLS-310G</b>	<b>LSWLS-310R</b>	<b>LSWLS-310M</b>	<b>LSWLS-310W</b>

## LED Warning Bars – Dual Colour

LED Modules	Current Draw @ 12V (A)	Flash Patterns	Amber/White <span style="color:red">NEW</span>	Amber/Green <span style="color:red">NEW</span>	Red/Blue
2	0.7	17	<b>LSWLS-32AW</b>	—	<b>LSWLS-32RB</b>
4	1.4	26	<b>LSWLS-34AW</b>	—	<b>LSWLS-34RB</b>
6	2.1	26	<b>LSWLS-36AW</b>	<b>LSWLS-36AG</b>	<b>LSWLS-36RB</b>
8	2.8	26	<b>LSWLS-38AW</b>	<b>LSWLS-38AG</b>	<b>LSWLS-38RB</b>
10	3.5	26	—	<b>LSWLS-310AG</b>	<b>LSWLS-310RB</b>



# LED Lighting

Covert Series



- Suction cups for quick and easy windscreen mounting.
- 30 flash patterns.
- Dimming function.
- User controls on rear of unit – Reset, Dimming, Flash select.
- 2.8mm lead to cigar plug.
- LEDs rated to 100,000 hours of operation.
- Permanent bolt down mounting option.
- Real-time flash pattern indicator.
- Low current draw.
- Multi-voltage.
- 5-year warranty.

12V  
24V

5Yrs

Voltage :	12-24V
Current Draw :	0.5A @ 12V
Flash Patterns :	30
Lens :	Polycarbonate
Body :	ABS
Approvals:	SAE-W-07
Light Source :	1W LEDs
Cable Length :	2.8m

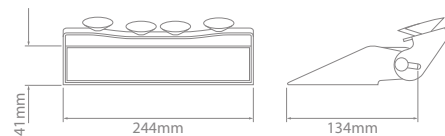
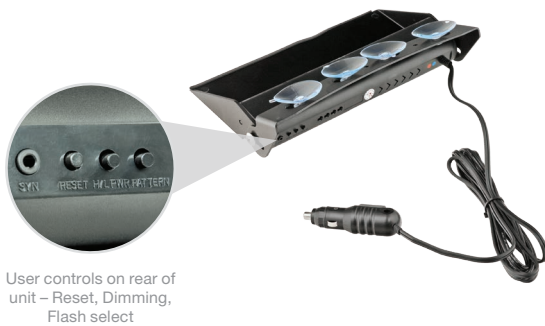

## Covert Series – 8 LED

Amber  
**LSDL-42TEAA**

Amber/Red  
**LSDL-42TEAR**

Amber/White  
**LSDL-42TEAW**

Red/Blue  
**LSDL-42TERB**

- Can be panel or surface mounted.
- 6 LEDs per light module.
- 22 flash patterns.
- Aluminium base.
- Environmentally sealed – IP67.
- Epoxy-encapsulated electronics for enhanced moisture & vibration protection.
- Can be synchronised.
- Multi-voltage.
- 5-year warranty.



Voltage : 12-30V  
 Current Draw : 1.6A @ 12V  
 Flash Patterns : 22  
 Lens : Polycarbonate  
 Base : Aluminium  
 Approvals : ECE R10  
 Light source : 1W LEDs  
 Ingress Protection : IP67

12V 30V IP67 5Yrs

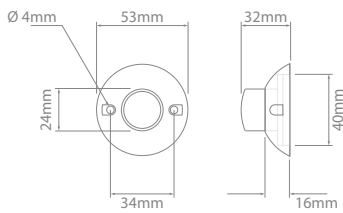

## LED Hide-A-Way Kits

Amber  
**LSHA01-AA**

Blue  
**LSHA01-BB**

Magenta  
**LSHA01-MM**

Red  
**LSHA01-RR**

White  
**LSHA01-WW**

Red/Blue  
**LSHA01-RB**

Other colour combinations available upon request.

Kit Contents:  
 2 x LED Lights  
 1 x Controller  
 2 x 3m Extension Cables





- Certified to comply with state transport operation regulations.
- Automatically activates when door opens and continues for 20–30 seconds after doors have closed.
- Microprocessor controlled with up to 4 outputs.
- 12V and 24V versions available.

# SCHOOL BUS



**WHEN LIGHTS FLASH**  
**SCHOOL BUS**



## Bus Warning Light Kits – NSW

12V                      24V  
**882-922/NLI      882-922-24/NLI**

Recommended for NSW bus installs.  
For current state regulations visit [www.rms.nsw.gov.au](http://www.rms.nsw.gov.au)

- Kit Contents:
- 1 x Toggle Switch
  - 1 x Pilot Lamp
  - 1 x Solid State Flasher Unit
  - 1 x Magnetic Reed switch for door sensor
  - 1 x Decal – “40km/h” – 440 x 440mm
  - 1 x Decal – “WHEN LIGHTS FLASH” 900 x 80mm
  - 1 x Decal – “SCHOOL BUS” – 900 x 150mm
  - Wiring Harnesses



**SCHOOL BUS**



## Bus Warning Light Kits – QLD & VIC

12V                      24V  
**882-923              882-923-24**

Recommended for Queensland & Victorian bus installs.  
For current state regulations visit [www.tmr.qld.gov.au](http://www.tmr.qld.gov.au) or [www.vicroads.vic.gov.au](http://www.vicroads.vic.gov.au)

- Kit Contents:
- 1 x Toggle Switch
  - 1 x Pilot Lamp
  - 1 x Solid State Flasher Unit
  - 1 x Magnetic Reed switch for door sensor
  - 1 x Decal – “Children Walking” – 400 x 305mm
  - 1 x Decal – “SCHOOL BUS” – 900 x 150mm
  - Wiring Harnesses

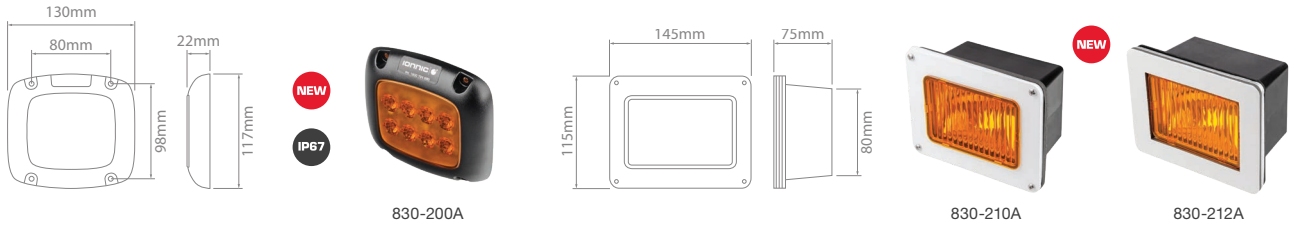

## Bus Warning Lights NEW

Part No.	Mount	Voltage	State
<b>830-200A</b>	Surface Mount	12-24	All
<b>830-210A</b>	Flush Mount	12-24	All
<b>830-212A</b>	Window	12-24	All

Flush Mount – Through mount (mounting hole required).  
 Window Mount – Inside Mount (uses double-sided adhesive).

For your current regulatory requirements visit your state's road regulation website.



882-909



882-911



882-914

## Bus Warning Light Kits – Spare Parts

Part No.	Description	State
<b>430-003</b>	Rectangular Light Gasket	QLD, VIC, SA
<b>TB403E</b>	Toggle Switch	All
<b>62026BL</b>	Pilot Lamp – 12V	All
<b>62030BL</b>	Pilot Lamp – 24V	All
<b>882-002</b>	Flasher Unit – 12-24V	QLD, VIC, SA
<b>886-012</b>	Flasher Unit – 12V	NSW
<b>886-013</b>	Flasher Unit – 24V	NSW
<b>882-902</b>	Switch Harness	QLD, VIC
<b>882-906</b>	Magnetic Reed Switch	All
<b>882-909</b>	Decal – “Children Walking” – 400 x 305mm	QLD, VIC
<b>882-911</b>	Decal – “40km/h” – 440 x 440mm	NSW
<b>882-914</b>	Decal – “SCHOOL BUS” – 900 x 150mm	All

For your current regulatory requirements visit your state's road regulation website.

